

PART NUMBER CODING

R _ B _ _ DHA _

NUMBER OF POSITIONS

MOUNTING STYLE

- D = .250" EARS, FLUSH MOUNTING
- N = NO MOUNTING EARS
- A = SIDE MOUNTING WITH #4-40 THREADED INSERTS
- R = NO MOUNTING EARS, WITH BOARD LOCKS
- S = SIDE MOUNTING

PLATING

ALL PLATINGS HAVE .000050" NICKEL UNDERPLATE

- | | | |
|-----|-----------------|--------------------------|
| | CONTACT SURFACE | TERMINATION |
| B = | .000010" GOLD | .000100" PURE TIN, MATTE |
| C = | .000030" GOLD | .000100" PURE TIN, MATTE |

REVISIONS				
REV.	ECO. NO	DESCRIPTION	DATE	BY
A	99	INITIAL RELEASE	04/12/06	JFW
B	161	ADDED 11 POSITION	04/12/06	JFW
C	985	REDRAW/REVISE. ALL AVAILABLE MOUNTINGS ADDED	04/12/06	MNH

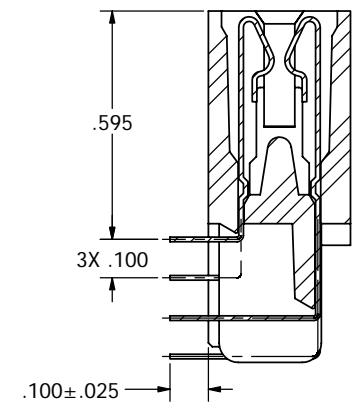
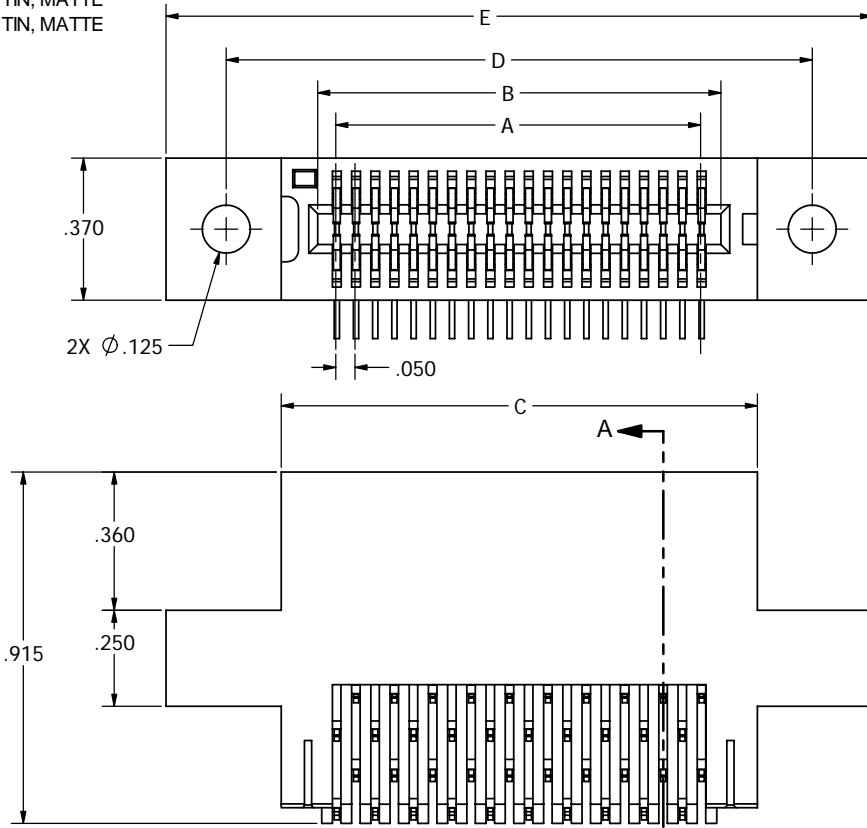

R _ B _ _ DHAD

- NOTES:**
- INSULATOR MATERIAL: PPS
 - CONTACT MATERIAL: PHOSPHOR BRONZE
 - PLATING: SEE PART NUMBER CODING
 - TEMPERATURE: -65 °C TO +125 °C
 - PROCESSING TEMP: 260 °C FOR 120 SECONDS MAX
 - UL FLAMMABILITY RATING: 94V-0
 - VOLTAGE RATING: 250 VDC MINIMUM AT SEA LEVEL.
 - CURRENT RATING: 3 AMP PER CONTACT PAIR
 - VOLTAGE DROP: 30 MILLI VOLT AT RATED CURRENT
 - INSULATION RESISTANCE: 5000 MEGA OHM
 - CONNECTOR IDENTIFICATION: THE PART SHALL BE MARKED WITH A PART NUMBER AND BARCODE
 - BOARD THICKNESS ACCOMMODATED: .062 ± .008"
 - BOARD INSERTION FORCE: 16 OZ MAX PER CONTACT PAIR WHEN USING A .062" TEST BLADE. INTERNAL INSPECTION TO BE PER SULLIN'S WORK INSTRUCTION W17.3-01.
 - BOARD WITHDRAWAL FORCE: 1 OUNCE MINIMUM PER CONTACT PAIR USING .062" PCB



RoHS COMPLIANT

CUSTOMER COPY

UNLESS OTHERWISE SPECIFIED: DIMENSIONS ARE IN INCHES(MM)		DRAWN		DATE	NAME
TOLERANCES: ANGULAR: ± 1° .XX ± .02 [.508] .XXX ± .005 [.1270] .XXXX ± .0005 [.0127] PARENTHEICAL INFORMATION IS FOR REFERENCE ONLY		SULLINS ELECTRONICS			
INTERPRET DIMENSIONS AND GEOMETRIC TOLERANCING PER: ANSI Y14.5-1984		DESCRIPTION CONNECTOR, EDGE CARD, RA			
PART NUMBER R _ B _ _ DHA _		SIZE C		DWG. NO. C10091	REV C
SCALE: 4:1		SHEET 1 OF 3			

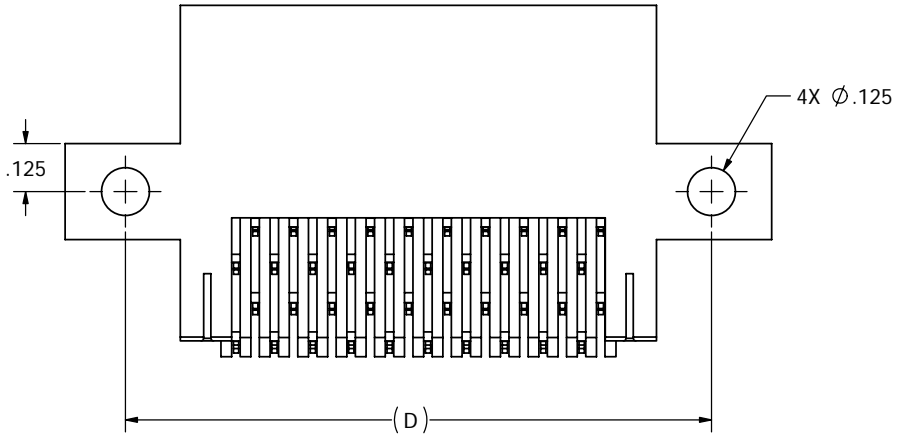
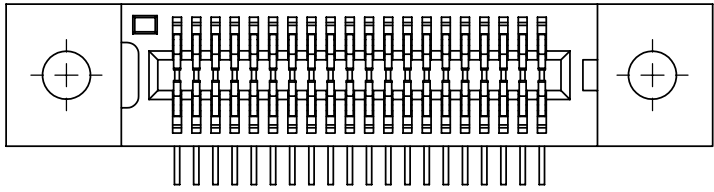

R_B__DHAS

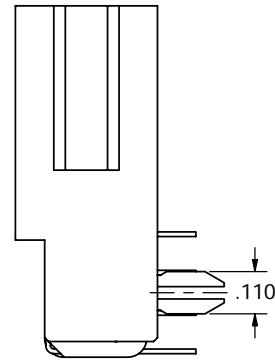
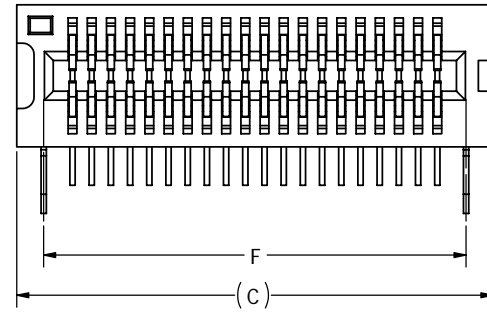

R_B__DHAR

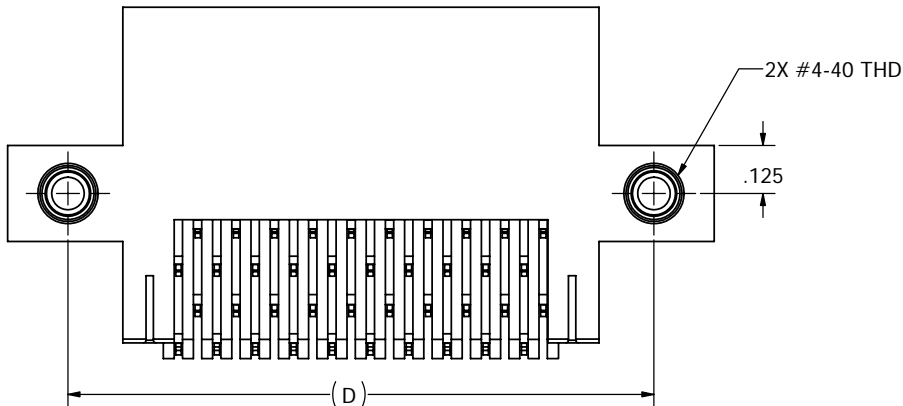
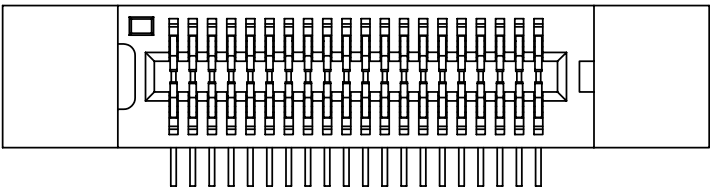

R_B__DHAA

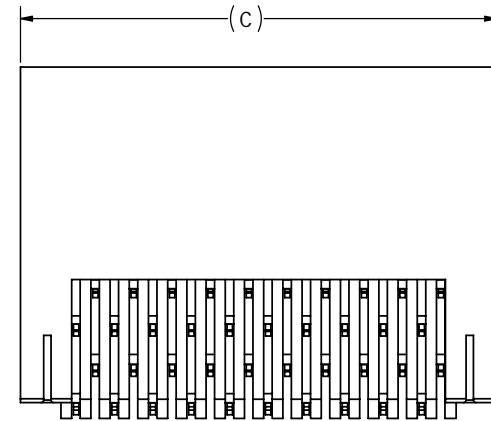

CUSTOMER COPY



RoHS COMPLIANT

UNLESS OTHERWISE SPECIFIED:
 DIMENSIONS ARE IN INCHES(MM)
 TOLERANCES:
 ANGULAR: ± 1°
 .XX = ± .02 [.508]
 .XXX = ± .005 [.1270]
 .XXXX = ± .0005 [.0127]
 PARENTHETICAL INFORMATION IS FOR REFERENCE ONLY

INTERPRET DIMENSIONS AND GEOMETRIC TOLERANCING PER: ANSI Y14.5-1984

DRAWN		DATE	NAME	SULLINS ELECTRONICS	
MNH				CONNECTOR, EDGE CARD, RA	
THE INFORMATION HEREIN CONTAINS PROPRIETARY INFORMATION OF SULLINS ELECTRONICS AND IS NOT TO BE REPRODUCED, USED OR DISCLOSED TO OTHERS FOR ANY PURPOSE EXCEPT AS SPECIFICALLY AUTHORIZED IN WRITING BY AN OFFICER OF SULLINS ELECTRONICS.				PART NUMBER	
				R_B__DHA__	
SIZE	DWG. NO.	REV			
C	C10091	C			
SCALE: 4:1			SHEET 2 OF 3		

PART NUMBER	NO OF POSITIONS	A±.005[0.13]		B±.005[0.13]		C±.015[0.38]		D±.010[0.25]		E±.020[0.51]		F±.010[0.25]	
		IN	MM	IN	MM	IN	MM	IN	MM	IN	MM	IN	MM
R_B05DHA_	5	0.200	5.08	0.300	7.62	0.490	12.45	0.776	19.71	1.090	27.69	0.350	8.89
R_B06DHA_	6	0.250	6.35	0.350	8.89	0.540	13.72	0.826	20.98	1.140	28.96	0.400	10.16
R_B09DHA_	9	0.400	10.16	0.500	12.70	0.690	17.53	0.976	24.79	1.290	32.77	0.550	13.97
R_B10DHA_	10	0.450	11.43	0.550	13.97	0.740	18.80	1.026	26.06	1.340	34.04	0.600	15.24
R_B13DHA_	13	0.600	15.24	0.700	17.78	0.890	22.61	1.176	29.87	1.490	37.85	0.750	19.05
R_B14DHA_	14	0.650	16.51	0.750	19.05	0.940	23.88	1.226	31.14	1.540	39.12	0.800	20.32
R_B15DHA_	15	0.700	17.78	0.800	20.32	0.990	25.15	1.276	32.41	1.590	40.39	0.850	21.59
R_B20DHA_	20	0.950	24.13	1.050	26.67	1.240	31.50	1.526	38.76	1.840	46.74	1.100	27.94
R_B22DHA_	22	1.050	26.67	1.150	29.21	1.340	34.04	1.626	41.30	1.940	49.28	1.200	30.48
R_B25DHA_	25	1.200	30.48	1.300	33.02	1.490	37.85	1.776	45.11	2.090	53.09	1.350	34.29
R_B30DHA_	30	1.450	36.83	1.550	39.37	1.740	44.20	2.026	51.46	2.340	59.44	1.600	40.64
R_B34DHA_	34	1.650	41.91	1.750	44.45	1.940	49.28	2.226	56.54	2.540	64.52	1.800	45.72
R_B35DHA_	35	1.700	43.18	1.800	45.72	1.990	50.55	2.276	57.81	2.590	65.79	1.850	46.99
R_B40DHA_	40	1.950	49.53	2.050	52.07	2.240	56.90	2.526	64.16	2.840	72.14	2.100	53.34
R_B45DHA_	45	2.200	55.88	2.300	58.42	2.490	63.25	2.776	70.51	3.090	78.49	2.350	59.69
R_B50DHA_	50	2.450	62.23	2.550	64.77	2.740	69.60	3.026	76.86	3.340	84.84	2.600	66.04
R_B55DHA_	55	2.700	68.58	2.800	71.12	2.990	75.95	3.276	83.21	3.590	91.19	2.850	72.39
R_B60DHA_	60	2.950	74.93	3.050	77.47	3.240	82.30	3.526	89.56	3.840	97.54	3.100	78.74
R_B64DHA_	64	3.150	80.01	3.250	82.55	3.440	87.38	3.726	94.64	4.040	102.62	3.300	83.82
R_B65DHA_	65	3.200	81.28	3.300	83.82	3.490	88.65	3.776	95.91	4.090	103.89	3.350	85.09
R_B66DHA_	66	3.250	82.55	3.350	85.09	3.540	89.92	3.826	97.18	4.140	105.16	3.400	86.36
R_B70DHA_	70	3.450	87.63	3.550	90.17	3.740	95.00	4.026	102.26	4.340	110.24	3.600	91.44
R_B75DHA_	75	3.700	93.98	3.800	96.52	3.990	101.35	4.276	108.61	4.590	116.59	3.850	97.79
R_B80DHA_	80	3.950	100.33	4.050	102.87	4.240	107.70	4.526	114.96	4.840	122.94	4.100	104.14
R_B85DHA_	85	4.200	106.68	4.300	109.22	4.490	114.05	4.776	121.31	5.090	129.29	4.350	110.49
R_B90DHA_	90	4.450	113.03	4.550	115.57	4.740	120.40	5.026	127.66	5.340	135.64	4.600	116.84
R_B95DHA_	95	4.700	119.38	4.800	121.92	4.990	126.75	5.276	134.01	5.590	141.99	4.850	123.19
R_B100DHA_	100	4.950	125.73	5.050	128.27	5.240	133.10	5.526	140.36	5.840	148.34	5.100	129.54
R_B105DHA_	105	5.200	132.08	5.300	134.62	5.490	139.45	5.776	146.71	6.090	154.69	5.350	135.89
R_B108DHA_	108	5.350	135.89	5.450	138.43	5.640	143.26	5.926	150.52	6.240	158.50	5.500	139.70
R_B110DHA_	110	5.450	138.43	5.550	140.97	5.740	145.80	6.026	153.06	6.340	161.04	5.600	142.24
R_B120DHA_	120	5.950	151.13	6.050	153.67	6.240	158.50	"N" MOUNTING ONLY				6.100	154.94

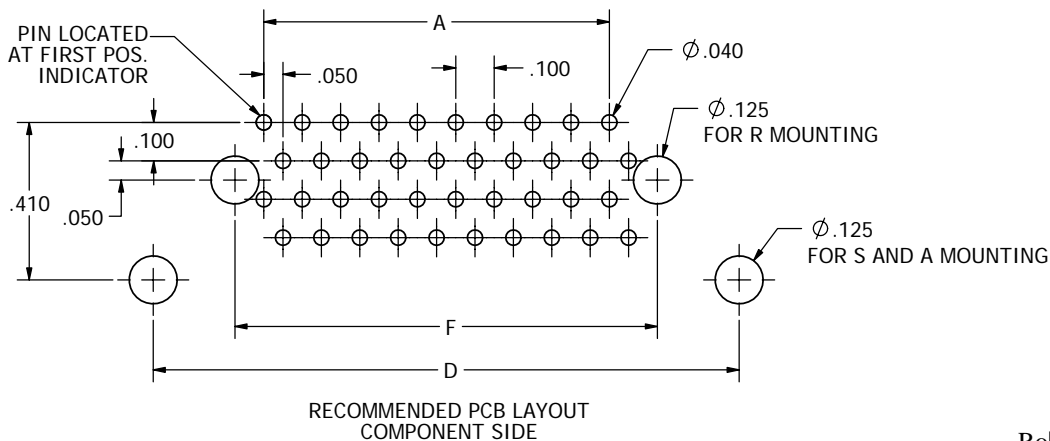

RoHS COMPLIANT

CUSTOMER COPY

UNLESS OTHERWISE SPECIFIED:
DIMENSIONS ARE IN INCHES(MM)

TOLERANCES:
ANGULAR: ± 1°
XX±.02 [.508]
.XXX±.005 [.1270]
XXXX±.0005 [.0127]
PARENTHETICAL INFORMATION IS FOR REFERENCE ONLY

INTERPRET DIMENSIONS AND GEOMETRIC TOLERANCING PER: ANSI Y14.5-1984

DRAWN	DATE	NAME
		MNH

THE INFORMATION HEREIN CONTAINS PROPRIETARY INFORMATION OF SULLINS ELECTRONICS AND IS NOT TO BE REPRODUCED, USED OR DISCLOSED TO OTHERS FOR ANY PURPOSE EXCEPT AS SPECIFICALLY AUTHORIZED IN WRITING BY AN OFFICER OF SULLINS ELECTRONICS.

DESCRIPTION
CONNECTOR, EDGE CARD, RA

PART NUMBER
R_B__DHA_

SIZE	DWG. NO.	REV
C	C10091	C

SCALE: 4:1

SHEET 3 OF 3